

Superbolt Expansion Bolts

Innovative technology for large machinery couplings

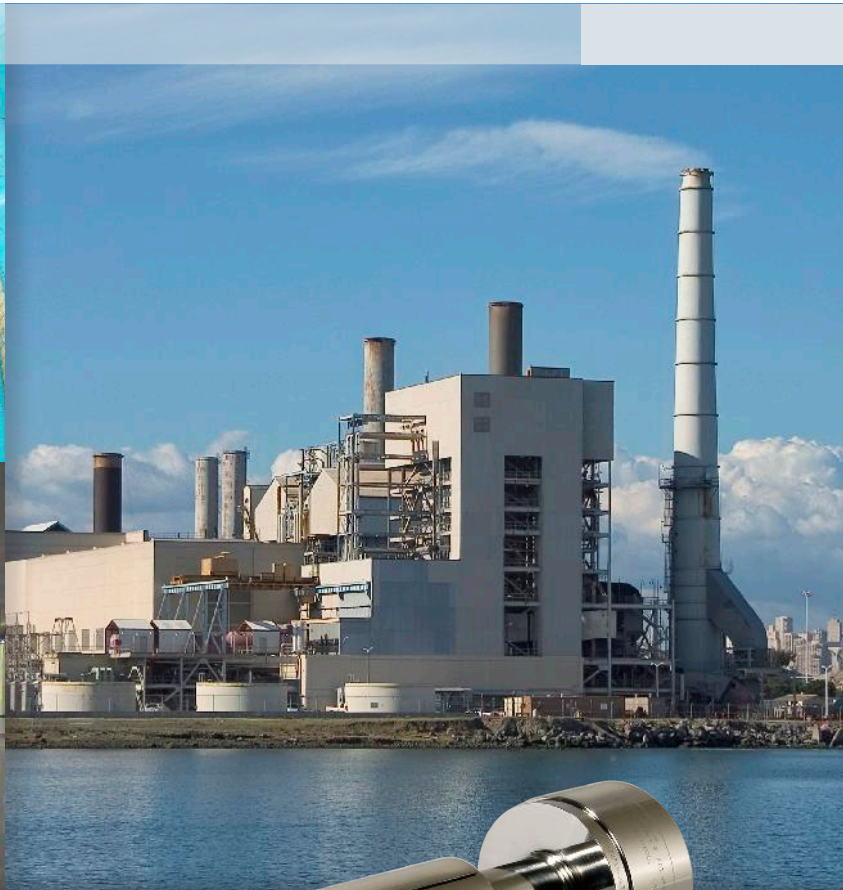

Authorised Distributor for INDIA
JEYSONS INDUSTRIES
Mob: +91-9819119925
Email: nord-lock@jeysons.com

Superbolt Expansion Bolts

Authorised Distributor for INDIA
JEYSONS INDUSTRIES
 Mob: +91-9819119925
 Email: nord-lock@jeysons.com

Problems

Heavy machinery requires bolting elements that can be easily installed and removed. This is especially true on large and high-performance flange couplings where the bolting elements produce an interference fit for proper torque transfer. However, these type of applications present a number of challenges:

Machining Requirements

Coupling flanges requiring tight or interference fit type bolting elements are expensive to manufacture. For proper functioning of these bolts, high demands are placed on the tolerances and the surface finishes of the bores. In many cases the bolts require precision tolerances and surface finishes as well. Even when the flanges are fitted together during assembly, further mechanical adjustments are often required.

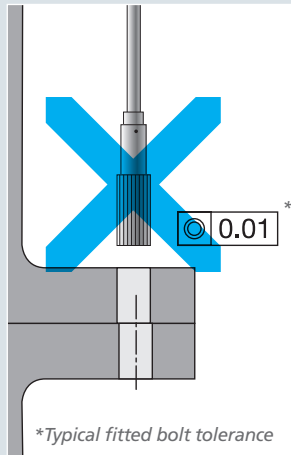

Tools

Large bolts require expensive and potentially hazardous tools for tightening and loosening:

- Slugging wrench: No control, very accident prone!
- Pre-heating: Difficult to control pre-load, time-consuming
- Torque multiplier: High friction load, inaccurate
- Hydraulic stretching: Large space requirement, expensive tools

Removal

Many interference fit type bolting elements are expensive to maintain and can only be removed using special tools and procedures. Often only expensive, improvised methods can be used for removing the bolting element (i.e. torch cutting).

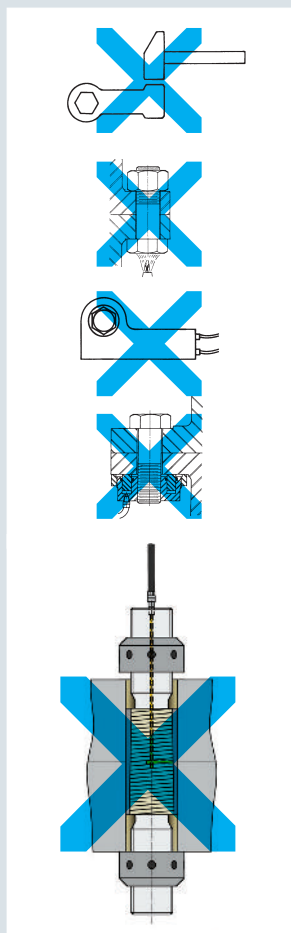

The Innovative Solution

Superbolt Expansion Bolts

Tensioner A pulls the tapered stud into the expanding tapered sleeve which is split, thus generating a radial force.

The spacer centers the split tapered sleeve relative to the split line.

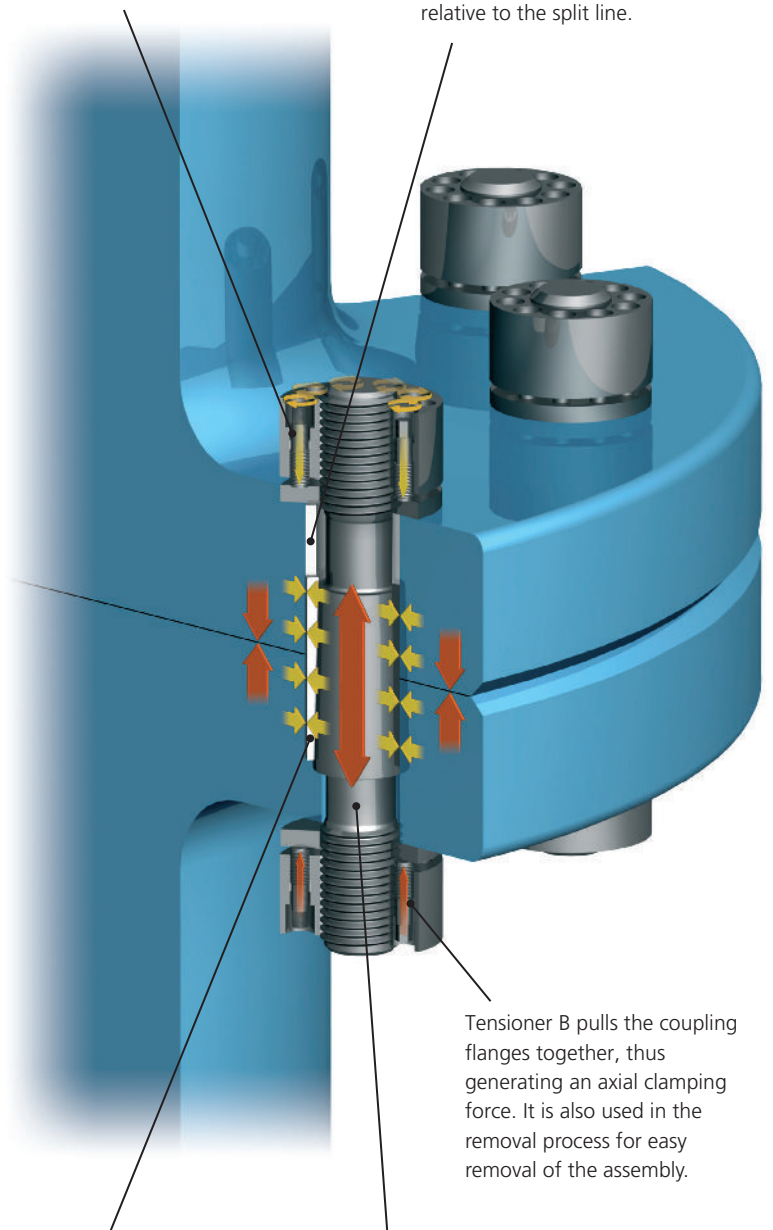

The split tapered sleeve creates a radial pre-load and transfers the external torque.

Tensioner B pulls the coupling flanges together, thus generating an axial clamping force. It is also used in the removal process for easy removal of the assembly.

The tapered stud transfers the forces required for the radial and axial frictional contacts. At the same time, it offers an additional form closure when over-loaded.

Advantages of Superbolt Expansion Bolts

- Substantial cost advantages: elimination of time-consuming and destructive removal procedures, expensive repair of distorted bores and also the purchase of new bolting elements.
- Safety: simple and quick installation and removal, only hand tools are required. Improved worker safety.
- No honing or machining required: MJTs compensate for small variations. Only line boring of holes is necessary.
- Re-usable: The Expansion Bolt split sleeve springs back to original size after each removal.

Authorised Distributor for INDIA
 JEYSONS INDUSTRIES
 Mob: +91-9819119925
 Email: nord-lock@jeysons.com

Product Development

Two simple innovations in the design of the expansion bolts have changed their performance so dramatically that they can now be considered a new bolting element:

- With the use of Superbolt multi-jackbolt tensioners (MJTs) extremely high pre-loads can be reached with simple tools.

No modifications are needed to replace your existing large fitted or interference fit bolts. The Superbolt Expansion Bolt features a tapered sleeve that is split along its length and expands. This design not only eliminates the radial clearance, but also creates a true radial pre-load. In operation, no one-sided lift-off of the tapered

sleeve from the bore occurs, as the split tapered sleeve remains in steady contact with the bore. The thrust, therefore, remains within the elastic range.

- Not only does the split tapered sleeve take up the clearances of the bore, but it also provides a strong radial force. The sleeve also increases the rigidity of the connection and eliminates harmful micro-movements in the split line. Furthermore, the sleeve can compensate wider tolerances of the bore.

Expansion Bolts are made to order - our team of engineers will work with you to meet the special requirements of your specific application.

Applications

Superbolt Expansion Bolts are used on many critical applications throughout various major industries: couplings on ship drives, turbines, engines, generators and compressors etc., as well as in the form of dowels for taking up transversal loads on foundation anchors.

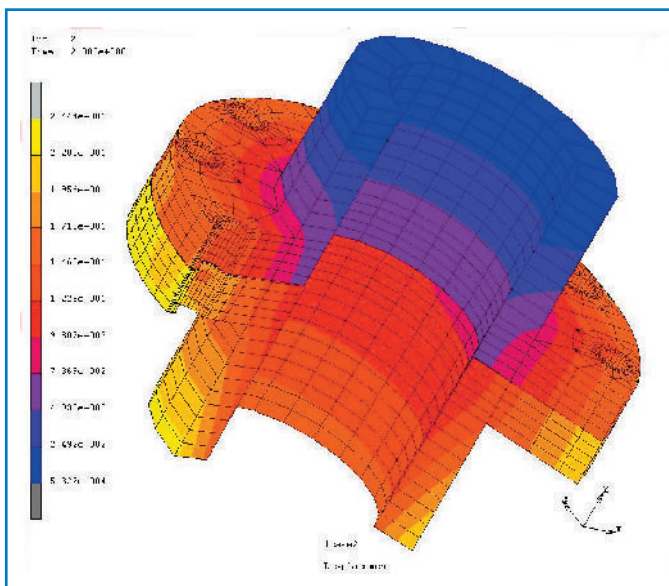

Finite element analysis with installed Expansion Bolts (100 x Enlargement)

Types of Superbolt Expansion Bolts

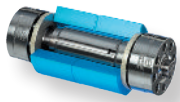

EBC
Expansion Bolt for through holes.
Access & operation from both sides.
ø 28–165 mm

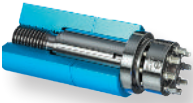

EBB
Expansion Bolt for blind holes.
Access & operation from one side.
ø 28–165 mm

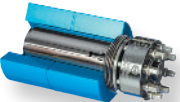

EBA
Expansion Bolt for threadless bores.
Access & operation from one side.
Dimensions on request.

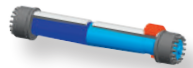

EBD
Expansion Bolt, double sided.
Access & operation from both sides.
Dimensions on request.

Proven and Certified

Superbolt Expansion Bolts have received type and individual approvals from several well-known institutes around the world. They include:

- American Bureau of Shipping
- DNV GL
- Lloyd's Register

Customer Cases

Propeller shaft coupling on tanker ship



Superbolt Expansion Bolts are used to tighten the flange connections on ship propeller shafts, which otherwise requires the coupling holes of the flange to be fitted accurately and machined on location when mounting the fitted bolts. The Expansion Bolts were tightened easily and quickly with only standard tools.

How they work

Installation

1. Slide split tapered sleeve (2) onto the tapered stud (1) and place together in the bore.
2. On side A, place spacer (3) in the bore to center split sleeve between the split line.
3. On side A, slide washer over the tapered stud (1) and screw on the tensioner (4) by hand.
4. Tighten jackbolts stepwise according to tightening procedure.
5. On side B, slide hardened washer over the tapered stud (1) and screw on the tensioner (5) by hand.
6. Tighten jackbolts stepwise according to tightening procedure
7. Verify tensioner torque on side A.

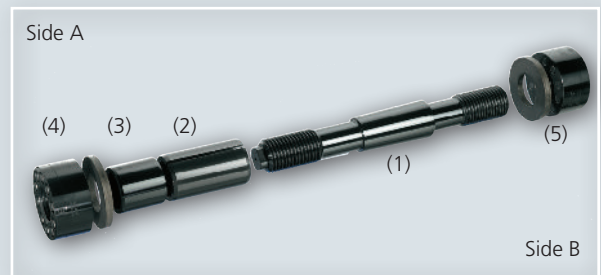

Removal

1. According to removal procedures, loosen the jackbolts on side A stepwise and unscrew the tensioner (4) by hand.
2. Tighten several jackbolts on side B further, in order to release the tapered stud (1) off the tapered sleeve (2).
3. Unscrew the tensioner (5) by hand.
4. Remove tapered stud (1), tapered sleeve (2) and spacer (3) from the bore.

Note: Detailed instructions are included with each shipment.

Pump/generator coupling shaft

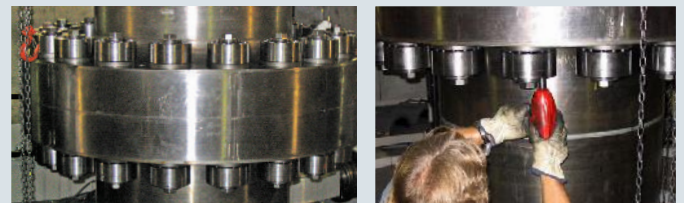

Superbolt Expansion Bolts replaced the tight fitted bolts on this Francis type pump generator shaft coupling at a Hydroelectric pump-storage facility. Compared to the previous conventional bolting method, Superbolt EBs eliminated the unsafe and time consuming installation and removal processes.

Nord-Lock, Inc. / Superbolt, Inc.

1000 Gregg St. • PO Box 683
Carnegie, PA 15106
Phone: 1-412-279-1149
Fax: 1-412-279-1185
Email: bolting@nord-lock.com
www.nord-lock.com

Authorised Distributor for INDIA
JEYSONS INDUSTRIES
Mob: +91-9819119925
Email: nord-lock@jeysons.com

NORD-LOCK®

© Copyright 2014 Nord-Lock Group. NORD-LOCK and SUPERBOLT are trademarks owned by different companies within the Nord-Lock Group. All other logos, trademarks, registered trademarks or service marks used herein are the property of the Nord-Lock Group. All rights reserved.