

Nord-Lock X-series washers

Product information



Authorised Distributor for INDIA
JEYSONS INDUSTRIES
Mob: +91-9819119925
Email: nord-lock@jeysons.com



A new evolution in bolt security



There are two main reasons why bolted joints fail: spontaneous bolt loosening and slackening. Traditionally, application design has involved trying to figure out which will have the biggest effect on the joint and choosing a solution to handle that one problem. It is a difficult compromise to make, especially when both could cause application failure.

New challenges call for a new evolution

New technologies and demands are creating unique design challenges. Designers need to take into account things such as thick surface coatings to fight corrosion, new sandwich composite technologies, and many more. Joints increasingly need to be able to withstand stresses from multiple fronts, including:

Spontaneous bolt loosening

- Vibration
- Dynamic loads

Slackening

- Settlement
- Relaxation

One solution for multiple challenges

Now, you can count on one solution to meet all your bolt securing needs. We are delighted to introduce the new Nord-Lock X-series washers —for bolt security without compromise.

Utilizing a unique multifunctional design, Nord-Lock X-series washers offer the highest security against both spontaneous bolt loosening and slackening. Combining Nord-Lock's unrivaled wedge-effect solution (to prevent spontaneous loosening) with an exceptional spring effect (to compensate for loss of preload due to slackening), Nord-Lock X-series washers give you a total security option for those situations in which there can be no compromise.



Spontaneous bolt loosening

Applications in heavy industries are constantly subjected to external forces, putting bolted joints at risk for spontaneous loosening due to vibration and dynamic loads.



Slackening

With the development of new materials and techniques — such as corrosion-resistant composites — slackening is a common problem due to settlement and relaxation.



A new dimension of safety

For 30 years, we have focused on providing the world's most effective bolt securing solutions. Nord-Lock original washers are recognized around the world for the ability to safely secure bolted joints exposed to severe vibration and dynamic loads. With the next generation of Nord-Lock washers, the X-series adds a new dimension of safety to bolt security.

New generation of washers:

- unrivaled wedge-effect solution to prevent spontaneous loosening
- an exceptional spring effect to compensate for loss of preload due to slackening
- quick and easy to install and remove with standard tools

Why Nord-Lock X-series?

The Nord-Lock X-series washer is an exceptional new product, giving customers extreme performance and safety, as well as the extra security of never having to risk making the wrong choice. With Nord-Lock X-series, we bring exciting new ideas to the bolt securing field that expand your design possibilities for excellent results.

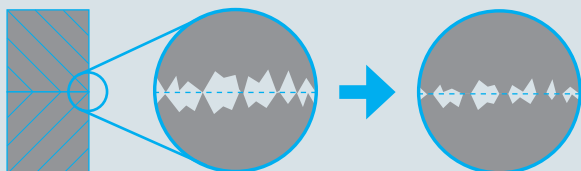

Settlement

When bolting materials together, the pressure will cause any irregularities on the surfaces to begin flattening immediately, with significant settlement within the first hours of tightening.

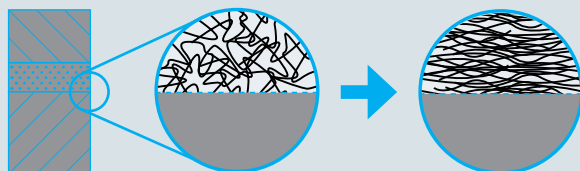

Relaxation

Certain materials, such as soft metals, composites, and polymers, become more compact over time, resulting in additional loss of preload.

Authorised Distributor for INDIA
 JEYSONS INDUSTRIES
 Mob: +91-9819119925
 Email: nord-lock@jeysons.com

A true multifunctional solution



Take advantage of the world's most effective wedge-locking concept coupled with a skilfully integrated spring effect for maximum bolt security!

Each washer pair has cams on one side and radial teeth on the opposite side to secure the bolted joint with tension instead of friction. The conical shape creates an elastic reserve in the bolted joint to compensate for the loss of preload and prevent slackening.



How it works

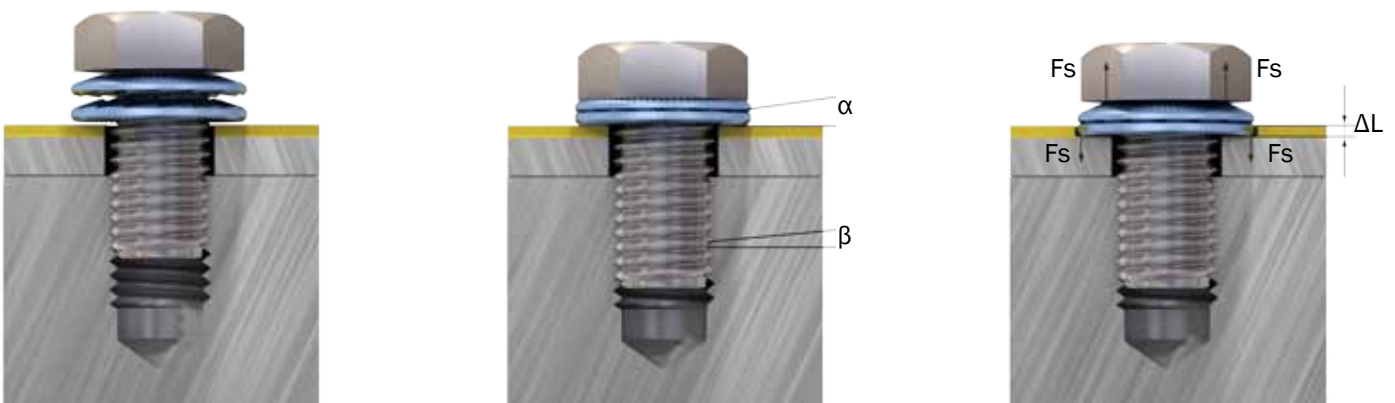

Upon tightening the fastener, the washers flatten and the serrations engage the contact surfaces. Since the cam angle (α) is greater than the thread pitch (β), the wedge-locking effect will prevent any rotation of the fastener. Directly after tightening, the joint settles and the fastener sinks into the surface material. The washers immediately deflect and the

spring effect (F_s) counteracts the slackening movement (ΔL) of the bolt, thereby preventing loss of preload on the joint. These multiple functions continuously act on the bolted joint to maintain preload and prevent spontaneous bolt loosening — serving as an effective solution for vibration, dynamic loads, settlement and relaxation.

Authorised Distributor for INDIA
JEYSONS INDUSTRIES
Mob: +91-9819119925
Email: nord-lock@jeysons.com



Proven performance against vibration

In addition to the thousands of live tests Nord-Lock personnel perform each year to ensure customer application enjoy secure performance, the various washer properties are rigorously tested by independent organizations.

The Junker test, according to DIN 65151, is considered the most severe vibration test for bolt connections. The test exposes the joint to transverse movements underneath the bolted head/nut, while continuously measuring the clamping force.

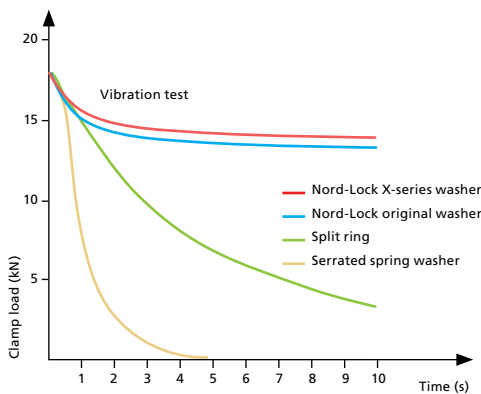

Fig 1: The Junker test shows that Nord-Lock's wedge-locking function safely secures the bolted connection, which is verified through the clear increase in tension during untightening. The Nord-Lock X-series kept the highest initial tension thanks to its additional spring effect.

Performance against slackening and vibration

Solutions available today handle mainly one of the reasons of bolt loosening — either spontaneous bolt loosening or slackening — but none is capable of securing against both. To see how different products function in various circumstances, we can look at the evolution of preload in a bolted joint over time. The graph below illustrates the behaviour of traditional bolt securing products with composite materials. The test has two phases: a static phase in which settlement is measured and a dynamic phase when vibration is added. The diagram compares how each of the solutions counteracts slackening and handles vibration.

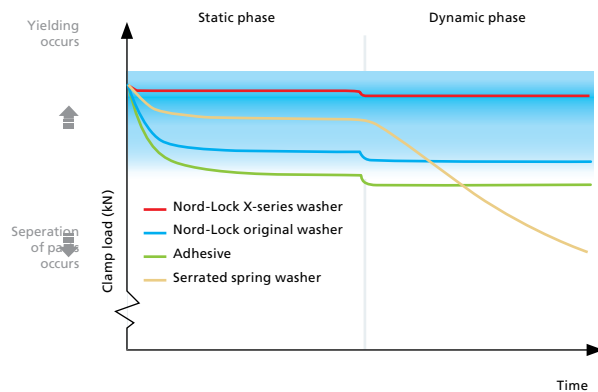

Fig 2: Diagram shows that Nord-Lock X-series performs better than any other alternatives currently available on the market when compensating slackening in static conditions and in preventing rotation of the fastener when the joint is exposed to vibration in the dynamic phase. With its unique, multifunctional solution, Nord-Lock X-series is the only product on the market that can secure bolts from both critical loosening factors at once. As shown in the graph, all bolted joints have a functional preload range in which the joint is safe. Problems start as soon as the preload falls outside the functional range. If the preload is too high, yielding occurs. If it is too low, there is separation or sliding between the parts. Only Nord-Lock X-series keeps you within the optimal limits.



Proven and certified by TÜV
 Nord-Lock X-series washers have been certified for safety and quality by TÜV, a leading international institute in quality and safety certification.

Authorised Distributor for INDIA
 JEYSONS INDUSTRIES
 Mob: +91-9819119925
 Email: nord-lock@jeysons.com

One solution for all your applications



1. Vibration & dynamic loads

In most demanding applications, joints are almost continually subjected to vibration and dynamic loads. The wedge-locking technology in Nord-Lock X-series washers has been proven as the most secure solution to prevent spontaneous bolt loosening in bolted joints for 30 years.



2. Painted or powder-coated surfaces

Surface treatments are common for applications that need to be protected from corrosion. Treating or painting a surface with a thick layer before installing a bolt can lead to slackening as the bolt sinks into the treated surface after tightening. Even a thin layer of mere millimeters can put joints at risk. The compensating spring effect in Nord-Lock X-series washers is an invaluable added benefit.



3. Soft metals

Many industries make use of soft metals such as copper and aluminum to achieve conductivity, sacrificial corrosive properties, and other benefits. These applications are often also subjected to significant vibration, dynamic loads and even slight movement (as is the case with cable shoes). Multifunctional Nord-Lock X-series washers offer an ideal solution for total bolt security.



4. Composites & polymers

Advances in polymers and sandwich composite technology — with its impressive strength-to-weight ratio and corrosion-resistant properties — allow industries to make applications lighter without losing strength. These materials are softer than the metal materials previously used and this makes slackening an additional challenge to add to the existing factors of vibration and dynamic loads. Nord-Lock's multifunctional wedge-locking concept is ideally suited to secure these new technologies.





5. Multiple clamped parts

The more parts you clamp together, the more you compound any slackening effect in the bolted joint. Settlement and relaxation are multiplied by each contact surface, as well as other elements such as surface treatments, thermal cycling, and vibration. The combined tension and spring actions in Nord-Lock X-series washers effectively handle all these factors.



6. Gasketed joints

All gaskets suffer from continued relaxation after initial tightening. Factors such as thermal cycling, soft metals, and vibration compound the effect. The resulting loss of clamp load can lead to leaks or even blowouts — a potentially devastating outcome. Nord-Lock X-series washers not only compensate for unavoidable relaxation in gaskets, but also handle the other factors acting on the joint, including vibration.



7. Thermal cycling

Most materials expand when subjected to higher temperatures. Therefore, critical designs involving cycling between hot and cool temperatures will have significant joint slackening as gaskets, bolts, and other parts expand and contract over time. The spring effect in Nord-Lock X-series washers offers an effective means to compensate for this cycling to maintain an even load.



8. Short clamp length

Achieving and maintaining a high clamping force becomes increasingly difficult the shorter the bolt length. Settlement within the bolted surfaces — even by microns — can lead in severe cases to total loss of preload. Combining both wedge-locking and spring-effect solutions, Nord-Lock X-series washers provide reliable locking even for very short clamp lengths, allowing designers to incorporate this type of bolted joint when necessary.

Benefits throughout your application's lifespan



Nord-Lock X-series washers work in distinctive ways to ensure a problem-free lifetime of your bolted joint — from design and installation to operation and maintenance.

Design



Assembly



As a multifunctional solution, Nord-Lock X-series washers save you time and money in the design phase.

- Simplify design for demanding applications with a single solution that secures against both spontaneous bolt loosening and slackening.
- Save costs by using one solution for all bolt securing needs.
- Use the added benefit of Nord-Lock Performance Services to guide you towards the most beneficial and effective bolt design.

With Nord-Lock X-series washers, your application is set up for maximum security and performance from the start.

- Save time with quick and easy installation using standard tools.
- Make the tightening process more accurate with a locking function unaffected by lubrication.
- Ensure a more accurate preload with defined and uniform friction.
- Facilitate inventory and logistical savings due to reduced item numbers.



Operation

Maintenance



Beyond the safe locking aspect, Nord-Lock X-series washers also improve the general performance of a bolted joint.

- Achieve increased operational reliability while significantly reducing the risk of unplanned production stops, accidents, and warranty claims.
- Invest money and time in profit-generating tasks rather than retightening procedures.

Every hour your line is down will cost you, not only in lost production or service, but in labor costs. Nord-Lock X-series washers can generate significant savings for both preventative and reactive maintenance.

- Decrease maintenance time with simple disassembly.
- Reduce the number of parts needed in stock to secure against vibration, dynamic loads, settlement and relaxation.
- Save time and money with a reusable solution, especially in industries with difficult access to the bolted joint.

Authorised Distributor for INDIA
JEYSONS INDUSTRIES
Mob: +91-9819119925
Email: nord-lock@jeysons.com

Nord-Lock X-series washers, steel

Dimension chart

Washer size	Bolt size		Flat position		Washer thickness T (mm)
	Metric	UNC	Inner Ø (mm)	Outer Ø (mm)	
NLX3	M3	#5	3.2	7.0	1.05
NLX3.5	M3.5	#6	3.7	7.6	1.09
NLX3.5sp	M3.5	#6	3.7	9.0	1.09
NLX4	M4	#8	4.2	7.6	1.19
NLX4sp	M4	#8	4.2	9.0	1.19
NLX5	M5	#10	5.3	9.0	1.48
NLX5sp	M5	#10	5.3	10.8	1.48
NLX6	M6		6.3	10.8	1.77
NLX6sp	M6		6.3	13.5	1.77
NLX1/4"		1/4"	6.7	11.5	1.75
NLX 1/4"sp		1/4"	6.7	13.5	1.75
NLX8	M8	5/16"	8.4	13.5	2.29
NLX8sp	M8	5/16"	8.4	16.6	2.29
NLX 3/8"		3/8"	10.0	16.6	2.70
NLX 3/8"sp		3/8"	10.0	21.0	2.70
NLX10	M10		10.5	16.6	2.95
NLX10sp	M10		10.5	21.0	2.95
NLX11	M11	7/16"	11.5	18.5	3.24
NLX12	M12		12.5	19.5	3.50
NLX12sp	M12		12.5	25.4	3.50
NLX 1/2"		1/2"	13.2	19.5	3.59
NLX 1/2"sp		1/2"	13.2	25.4	3.59
NLX14	M14	9/16"	14.6	23.0	4.03
NLX14sp	M14	9/16"	14.6	29.0	4.03
NLX16	M16	5/8"	16.6	25.4	4.74
NLX16sp	M16	5/8"	16.6	30.7	4.74
NLX18	M18		18.7	29.0	5.36
NLX18sp	M18		18.7	34.5	5.36
NLX3/4"		3/4"	19.8	30.7	5.66
NLX3/4"sp		3/4"	19.8	39.0	5.66
NLX20	M20		20.7	30.7	6.01
NLX20sp	M20		20.7	39.0	6.01
NLX22	M22	7/8"	22.8	34.5	6.80
NLX22sp	M22	7/8"	22.8	42.0	6.80
NLX24	M24		24.8	39.0	7.19
NLX24sp	M24		24.8	47.0	7.19
NLX1"		1"	26.4	39.0	7.63
NLX1"sp		1"	26.4	48.5	7.63
NLX27	M27		27.9	42.0	8.28
NLX27sp	M27		27.9	51.0	8.28
NLX30	M30	1 1/8"	31.0	47.0	9.06
NLX30sp	M30	1 1/8"	31.0	55.0	9.06
NLX33	M33	1 1/4"	34.1	51.0	10.05
NLX33sp	M33	1 1/4"	34.1	60.0	10.05
NLX36	M36	1 3/8"	37.2	55.0	10.87
NLX36sp	M36	1 3/8"	37.2	65.0	10.87
NLX39	M39	1 1/2"	40.3	60.0	11.96
NLX42	M42		43.4	65.0	12.74



Torque guidelines, bolt grade 8.8

Washer size	Bolt size	Pitch [mm]	Oil, G _F =75% μ _{th} =0,10, μ _b =0,16		Cu/C paste* G _F =75% μ _{th} =0,11, μ _b =0,16		Dry, G _F =62% μ _{th} =0,15, μ _b =0,18	
			Torque [Nm]	Clamp load [kN]	Torque [Nm]	Clamp load [kN]	Torque [Nm]	Clamp load [kN]
NLX8	M8	1.25	25	18	30	18	25	15
NLX10	M10	1.5	49	28	49	28	50	23
NLX12	M12	1.75	85	40	83	40	85	33
NLX16	M16	2.0	205	75	197	75	208	62

Torque guidelines, bolt grade 10.9

Washer size	Bolt size	Pitch [mm]	Oil, G _F =71% μ _{th} =0,13, μ _b =0,14		Cu/C paste* G _F =75% μ _{th} =0,11, μ _b =0,15	
			Torque [Nm]	Clamp load [kN]	Torque [Nm]	Clamp load [kN]
NLX8	M8	1.25	34	23	44	25
NLX10	M10	1.5	67	37	73	39
NLX12	M12	1.75	115	54	121	57
NLX16	M16	2.0	279	100	281	106

Torque guidelines, bolt grade 12.9

Washer size	Bolt size	Pitch [mm]	Oil, G _F =71% μ _{th} =0,13, μ _b =0,12		Cu/C paste* G _F =75% μ _{th} =0,11, μ _b =0,15	
			Torque [Nm]	Clamp load [kN]	Torque [Nm]	Clamp load [kN]
NLX8	M8	1.25	38	28	47	30
NLX10	M10	1.5	75	44	93	47
NLX12	M12	1.75	128	65	151	68
NLX16	M16	2.0	311	120	342	127

*Cu/C paste = Copper/graphite paste (Molykote® 1000)

G_F = ratio of yield point

μ_{th} = thread friction

μ_b = washer friction

1 N = 0.225 lb

1 Nm = 0.738 ft-lb

Torque guidelines for remaining sizes not available at the time of printing.
Contact your local Nord-Lock office for more information.

Ø_i (mm)

NLX3–NLX5 ±0.09

NLX6–NLX8 ±0.11

NLX3/8"–NLX16 ±0.135

NLX18–NLX27 ±0.165

Ø_o (mm)

NLX3–NLX5 ±0.110

NLX6–NLX10 ±0.135

NLX11–NLX18 ±0.165

NLX 3/4"–NLX27 ±0.195

Ø_o (mm)

NLX3,5sp–NLX4sp ±0.11

NLX5sp–NLX8sp ±0.135

NLX3/8"sp–NLX14sp ±0.165

NLX16sp–NLX1"sp ±0.195

NLX27sp ±0.230

T (mm)

NLX3–NLX16 +0.00/-0.28

NLX18–NLX20 +0.00/-0.32

NLX22–NLX27+0.00/-0.36

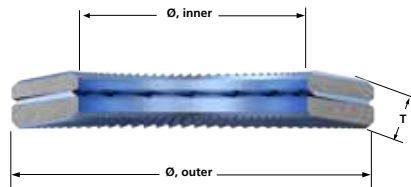

X-series washer material / type guide

Steel type	Examples of application	Washer types	Treatment Surface coating	Washer hardness	Corrosion resistance	Bolt grades	Temperature range
EN 1.7225 or equivalent	General steel applications	Regular outer diameter (NLX3–NLX42) Enlarged outer diameter (NLX3,5sp–NLX36sp)	Through hardened Delta Protekt® base coat (KL100) and top coat (VH302GZ)	≥ 485 HV1	Minimum 600 hours in salt spray test (according to ISO9227)	Up to 12.9	-40°C to 150°C

Authorised Distributor for INDIA
JEYSONS INDUSTRIES
Mob: +91-98191 19925
Email: nord-lock@jeysons.com

Nord-Lock X-series washers, stainless steel

Dimension chart

Washer size	Bolt size		Flat position		Washer thickness T (mm)
	Metric	UNC	Inner Ø (mm)	Outer Ø (mm)	
NLX3ss	M3	#5	3.2	7.0	1.01
NLX3.5ss	M3.5	#6	3.7	7.6	1.05
NLX3.5spss	M3.5	#6	3.7	9.0	1.05
NLX4ss	M4	#8	4.2	7.6	1.15
NLX4spss	M4	#8	4.2	9.0	1.15
NLX5ss	M5	#10	5.3	9.0	1.39
NLX5spss	M5	#10	5.3	10.8	1.39
NLX6ss	M6		6.3	10.8	1.74
NLX6spss	M6		6.3	13.5	1.74
NLX1/4"ss		1/4"	6.7	11.5	1.71
NLX1/4"spss		1/4"	6.7	13.5	1.71
NLX8ss	M8	5/16"	8.4	13.5	2.16
NLX8spss	M8	5/16"	8.4	16.6	2.16
NLX3/8"ss		3/8"	10.0	16.6	1.35
NLX3/8"spss		3/8"	10.0	21.0	1.35
NLX10ss	M10		10.5	16.6	2.87
NLX10spss	M10		10.5	21.0	2.87
NLX11ss	M11	7/16"	11.5	18.5	3.16
NLX12ss	M12		12.5	19.5	3.37
NLX12spss	M12		12.5	25.4	3.37
NLX1/2"ss		1/2"	13.2	19.5	2.20
NLX1/2"spss		1/2"	13.2	25.4	2.20
NLX14ss	M14	9/16"	14.6	23.0	4.05
NLX14spss	M14	9/16"	14.6	29.0	4.05
NLX16ss	M16	5/8"	16.6	25.4	4.46
NLX16spss	M16	5/8"	16.6	30.7	4.46
NLX18ss	M18		18.7	29.0	5.34
NLX18spss	M18		18.7	34.5	5.34
NLX3/4"ss		3/4"	19.8	30.7	4.00
NLX3/4"spss		3/4"	19.8	39.0	4.00
NLX20ss	M20		20.7	30.7	5.63
NLX20spss	M20		20.7	39.0	5.63
NLX22ss	M22	7/8"	22.8	34.5	6.83
NLX22spss	M22	7/8"	22.8	42.0	6.83
NLX24ss	M24		24.8	39.0	7.12
NLX24spss	M24		24.8	47.0	7.12
NLX1"ss		1"	26.4	39.0	5.50
NLX1"spss		1"	26.4	48.5	5.50
NLX27ss	M27		27.9	42.0	8.12
NLX27spss	M27		27.9	51.0	8.12
NLX30ss	M30	1 1/8"	31.0	47.0	8.79
NLX30spss	M30	1 1/8"	31.0	55.0	8.79
NLX33ss	M33	1 1/4"	34.1	51.0	9.89
NLX36ss	M36	1 3/8"	37.2	55.0	10.36
NLX39ss	M39	1 1/2"	40.3	60.0	11.56
NLX42ss	M42		43.4	65.0	12.13

Torque guidelines not available at the time of printing. Contact your local Nord-Lock office for more information.

Ø_i (mm)

NLX3ss–NLX5ss ±0.08

NLX6ss–NLX8ss ±0.11

NLX3/8"ss–NLX16 ±0.135

NLX18ss–NLX27ss ±0.165

Ø_o (mm)

NLX3ss–NLX5ss ±0.11

NLX6ss–NLX10ss ±0.135

NLX11ss–NLX18ss ±0.165

NLX 3/4"ss–NLX27ss ±0.195

Ø_o (mm)

NLX3.5spss–NLX4spss ±0.011

NLX5spss–NLX8spss ±0.135

NLX3/8"spss–NLX14spss ±0.165

NLX16spss–NLX1"spss ±0.195

NLX27spss ±0.230

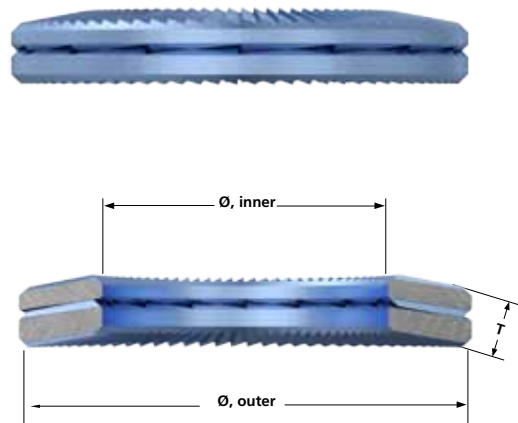

X-series washer material / type guide

Steel type	Examples of application	Washer types	Treatment Surface coating	Washer hardness	Corrosion resistance	Bolt grades	Temperature range
EN 1.4404 or equivalent	General stainless steel applications. Non chlorine / acid environments	Regular outer diameter (NLX3ss–NLX42ss) Enlarged outer diameter (NLX3.5spss–NLX30spss)	Surface hardened	≥ 385HV1	PREN 27	Up to A4-80	-160°C to 500°C

Authorised Distributor for INDIA
JEYSONS INDUSTRIES
 Mob: +91-9819119925
 Email: nord-lock@jeysons.com

How to use Nord-Lock X-series washers



Installing the washers

The pre-assembled washers are installed in pairs, cam face to cam face, with the concave sides both facing the same direction towards the contact surface.

Tightening

You can tighten Nord-Lock washers with standard tools according to the guidelines (on page 10-11). Tightening guidelines for other bolt grades are available through your Nord-Lock representative.

Untightening

Untightening Nord-Lock washers is as simple as tightening. Note that since the locking function is not based on increased friction, the untightening torque is generally lower than the tightening torque. Therefore it is not possible to measure off torque as verification of the locking function.

Reusing Nord-Lock X-series washers

Nord-Lock X-series washers can normally be reused. As with all fasteners, they should be inspected for wear before reassembly. Make sure the washers are installed correctly each time you reuse them (see "Installing the washers" above). We recommend lubricating fasteners before reuse to minimize torsion and changes in friction conditions.

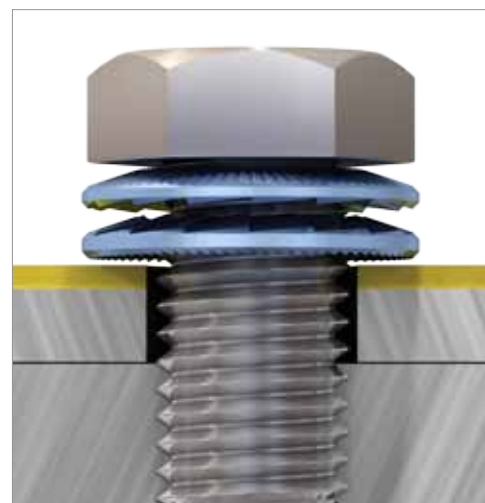

Nord-Lock X-series washers are simple and easy to use.

Traceability

Nord-Lock products are rigorously tested in all steps of production to verify that the quality requirements are met. Each batch is assigned a control number which ensures full traceability down to first assembly. The 'NORD-LOCK X' designation, the unique control number and a type code are laser marked on the upper washer in every washer pair, confirming that the product is a genuine Nord-Lock article.

Nord-Lock X-series washers with enlarged outer diameter

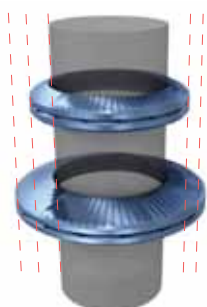

All Nord-Lock X-series washers are available with an enlarged outer diameter, referred to as SP washers. SP washers are designed for use on large/slotted holes, painted/sensitive surfaces or soft materials. Use Nord-Lock SP washers with flanged bolts or nuts for optimum load distribution.

\varnothing inner regular = \varnothing inner SP
 \varnothing outer regular < \varnothing outer SP

X-series laser marking, type code table

Washer type	Code
Steel washers, Delta Protekt® coating	flZn
Stainless steel washers	SS

Authorised Distributor for INDIA
 JEYSONS INDUSTRIES
 Mob: +91-9819119925
 Email: nord-lock@jeysons.com

Nord-Lock bolted joint guide



Tapped holes

Nord-Lock X-series washers safely lock the bolt against the underlying surface. *Shown here with a painted surface.*



Through holes

As for all locking washers, through holes require two pairs of Nord-Lock X-series washers — one pair for securing the bolt and a second pair for securing the nut. *Shown here with a plastic component.*



Stud bolts

Nord-Lock X-series washers safely lock the nut on stud bolts and eliminate the need for adhesives. *Shown here with a corrosion-protected surface.*



Counter bores

The outer diameter of Nord-Lock X-series washers is designed for counter-bore holes (i.e., the washers fit under the head of standard bolts). *Shown here with a composite material.*



Applications with large/slotted holes

To optimize the load distribution for applications with large/slotted holes, use a flanged nut/bolt together with Nord-Lock X-series "SP" washers with enlarged outer diameter. *Shown here with a painted surface.*



Designs for which Nord-Lock X-series washers are not recommend:

- Mating surfaces that are not locked in place (see left figure)
- Mating surfaces harder than the washers
- Wooden mating surfaces
- Non-preloaded joints

If your application corresponds to one or more of these design elements, contact your Nord-Lock representative and we will help you find an alternative solution.

Authorised Distributor for INDIA
JEYSONS INDUSTRIES
Mob: +91-9819119925
Email: nord-lock@jeysons.com

From original to multifunctional wedge-locking washers



Nord-Lock X-series washer

Nord-Lock X-series washers give you ultimate bolt security independent of your critical loosening factor. Whether you face the risk of spontaneous bolt loosening due to vibration and dynamic loads, or slackening as a result of settlement and relaxation, Nord-Lock X-series is your one solution for all challenges. Bolt security without compromise.



Nord-Lock original washer

Nord-Lock original washers give you bolt security in applications with severe vibration and dynamic loads. Rigorously tested and proven as the most secure solution to prevent loosening in bolted joints, Nord-Lock original washers have kept you safe for 30 years.

For those situations when you cannot say with certainty whether spontaneous bolt loosening or slackening is the bigger issue — or when you know both are equal risks and could cause application failure — there simply can be no compromise. Always choose maximum security. Nord-Lock X-series makes it easy, giving you the highest security available to handle both these problems in a single, convenient solution.

Authorised Distributor for INDIA
JEYSONS INDUSTRIES
Mob: +91-9819119925
Email: nord-lock@jeysons.com

Your partner in bolt securing



Partnering for more secure and efficient operations

When you choose Nord-Lock, you choose not only a supplier or manufacturer, but a partner. Our global team of experts in bolted joints guides you towards the most beneficial bolt design to solve bolt-securing problems in the most demanding applications.

Nord-Lock offers continuous support — from design phase, testing, and verification through installation and maintenance — sharing our experience, knowledge, and creativity to help our clients achieve the outstanding results they require. Let Nord-Lock be your partner in bolt optimization.

Performance Services

Nord-Lock Performance Services is a partnership project offered to key customers. The purpose is to increase profitability by generating a complete and detailed view of the design of bolted connections and securing methods. As each project is designed to meet customer-specific needs and challenges, both current applications and future designs can be investigated. In addition, our global chain of services supports you throughout sourcing, design/production, and aftermarket.

Nord-Lock global chain of services

Sourcing

Life Cycle Profitability and cost justification

Cost savings generated by optimized bolted joints.

Design / Production

Field Application Engineer, Technical Centers & Project Engineering

Joint calculation and simulation. Real life testing and validation. Custom designs.

Aftermarket

On-site and remote product training as well as service and retrofitting

Increasing the knowledge for operators and engineers. Installation support.

Authorised Distributor for INDIA
JEYSONS INDUSTRIES
Mob: +91-9819119925
Email: nord-lock@jeysons.com

Your **trusted** global partner in bolt optimization



Joining parts together is one of the most critical steps when delivering a product or system. The Nord-Lock Group is focused on solving the toughest bolting challenges. We offer a unique combination of bolting expertise and a wide product range, including wedge-locking technology and Superbolt tensioners — all designed and developed in-house.

Nord-Lock holds decades of documented success in every major industry, including oil and gas, energy, transportation and mining. Our Production System includes rigorous internal testing and full traceability, and our products hold several certificates from independent institutes including AbP, ABS, DIBt, DNV and TÜV.

The tools available through Nord-Lock Performance Services add value throughout a project and ensure that your bolting application pays back multiple times. We can also assist you in the design phase with bolted joint simulation and testing. Additionally, we help you ensure successful operations over time with our onsite support and remote product training.

Our mission is to safeguard human lives and customer investments by securing the world's most demanding applications. The Nord-Lock Group looks forward to being your partner in bolt optimization.

Authorized distributor:

JEYSONS INDUSTRIES
L11 to L14, Chaudhary Industry,
Vakan Pada, Nalasopara East,
Tal. Vasai, Dist. Thane 401209.
Mob: +91-9819119925
Email: nord-lock@jeysons.com

© Copyright 2012 Nord-Lock International AB. NORD-LOCK is a trademark owned by Nord-Lock International AB or its affiliates. All other logos, trademarks, registered trademarks or service marks used herein are the property of Nord-Lock International AB and its affiliates or licensors. All rights reserved.

Nord-Lock Group
Tel: +46 (0)31 7192 300, Fax: +46 (0)40 240 851
Email: info@nord-lock.com
www.nord-lock.com

NORD-LOCK®
Bolt securing systems